

# FTRV Smart Architectural Troffer Bluetooth Controlled Integrated Dual (Occupancy & Daylight) Sensor

## Product Description

The FTRV Series LED troffer portfolio offers a unique design with 2x2 and 2x4 options that can easily accommodate recessed, surface mount or drywall installations for both new construction and renovation/retrofit applications also with IC Rating. Using the high efficacy and high-quality LED diode technology, the FTRV delivers up to 6512 lumen's of exceptional 85+ CRI light while achieving up to 151 lumen's per watt. DLC Premium listing with a variety of dimming options that increase energy savings and help meet local energy codes. The most intuitive and easiest to install intelligent light solution on the market, delivering up to 80% energy savings.

## Features & Benefits

- 85+ CRI , Higher color rendering index with remarkable true color consistency
- State of the art integrated wireless control options integrates functional elements into aesthetics to achieve a sleek architectural look while delivering industry setting performance and efficiency
- Occupancy and Daylight - Dual integrated sensor technology
- BlueTooth control + Occupancy and Daylight - Dual integrated system with smartphone and iPad/tablet access comes with; scheduling, grouping, trim down, customized scenes, Linking groups/fixtures together
- IC Rated

## Mounting Options

- Recessed
- Surface Mounting Kit
- Drywall Flange Mounting Kit

## Regulatory & Voluntary Qualifications

- UL, IP40 Rated, IC Rated
- Most of our products are DLC listed, qualifying them for the highest rebates. Please check individual product specs for DLC status. Refer to DLC website by clicking this link: <https://www.designlights.org>

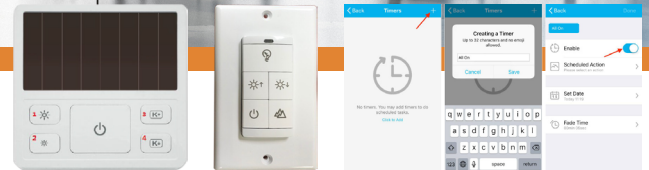

## Performance Summary

Efficacy up to: 151 l/pw

CRI up to: 85 cri

CCT: 3000K / 3500K / 4000K / 5000K

Dimming: 0-10vac

Operating Temp: -25° - +55°C

Input Voltage: AC 100-277vac

Operating Frequency: 50 / 60Hz

Power Factor: ≥ 0.95

Beam Angle: 120°

Sizes: 2x2, 2x4

L70 Lifetime Hours: 206,000 (TM21 calculated)

L80 Lifetime Hours: 133,000 (TM21 calculated)

L90 Lifetime Hours: 63,000 (TM21 calculated)



## FTRV Series Specification Summary

Product Number	FTRV22-HE-20W	FTRV22-26W	FTRV22-HE-26W	FTRV22-32W	FTRV24-HE-26W	FTRV24-32W	FTRV24-40W	FTRV24-50W
Efficacy l/pw	145	132	151	131	144	129	129.5	130
Input Power Watts @3500K	20.18	25.77	24.95	32.44	26.56	32.51	41.19	49.96
Lumens @ 3500K	2915	3394	3767	4235	3822	4202	5078	6470
Lumens @ 4000K	2953	3408	3769	4260	3837	4241	5182	6484
Lumens @ 5000K	3002	3432	3770	4267	3855	4319	5335	6512
Input Voltage	100-277vac							
CRI	83.2	83.5	83.2	82.5	83.9	83.4	80	84.9
THD @ 120VAC	13.36%	7.75%	10.13%	7.69%	18.71%	7.79%	10%	8.13%
IP Rating	IP40							
CCT/Kelvin Temp Options	30K( NO DLC) / 35 / 40 / 50 Kelvin							
Qualifications	UL / DLC 4.2 - (No DLC on all 3000K fixtures)							
Dimming & Control	0-10V							
Operating Frequency	50/60Hz							
Beam/Field Angle	120°							
Power Factor	0.90	0.91	0.90	0.93	0.93	0.93	0.90	0.95
TM21 (calculated Lifetime Hours)	L70 @ 206,000 Hrs / L80 @ 130,000 Hrs / L90 @ 63,000 Hrs							
Ambient Working Temp	-25°C to +55°C (-13°F ~ +131°F) Ambient							
Max Dimensions (in)	23.74" x 23.74" x 2.83"				23.74" x 47.99" x 2.83"			
Total Weight	8 lbs				11 lbs			
Limited Warranty	10 Yrs.							

Notes Values are nominal unless noted +/- 5%  
Specifications change without notice

## FTRV Series Product Ordering Guide

Example: FTRV22-26W-35K-PIDS-EM15

Product	CCT/Color Temp	Voltage	Controls & Dimming	Emergency Backup
FTRV22-HE-20W	30K (3000 Kelvin)	Blank (100-277vac) STD	Blank (0-10v) STD	Blank (No EM) STD
FTRV22-26W	35K (3500 Kelvin)			
FTRV22-HE-26W	40K (4000 Kelvin)			
FTRV22-32W	50K (5000 Kelvin)			
FTRV24-HE-26W				
FTRV24-32W				
FTRV24-40W				
FTRV24-50W				

*\*=Special Order Item (Consult Customer Service)*

## Smart Phone Configuration & Control Application

### iOS App

iOS App requires the iPhone in iOS 8.0 or latest version, Open "App Store", search "Light Remote LED", find the App and install. The App icon is following:

### Android App

Android App requires the smart phone in Android 4.3 or latest version and Bluetooth in 4.0 or latest version, Open "App Store", search "Light Remote LED", find the App and install. The App icon is following:

Smart-phone App:

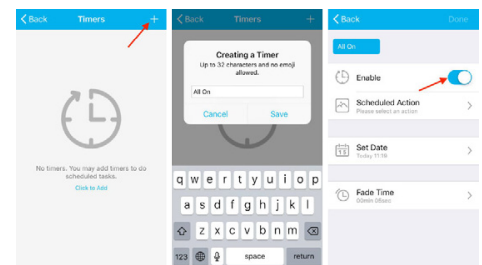

## Field Installed Accessories

Product Number Description

WCSP	Battery-less Solar Powered Wireless Wall Control Panel
WSBP	Battery Powered Wireless Wall Switch (Bluetooth enabled, Fits in a standard wall switch electrical box, Triple AAA battery's not included)
SMK22	24"x24" Surface Mounting Kit
SMK24	24"x48" Surface Mounting Kit
DWK2X2	24"x24" Surface Mounting Flange Kit
DWK2X4	24"x48" Drywall Mounting Flange Kit

Wall Control Panel (WCSP):

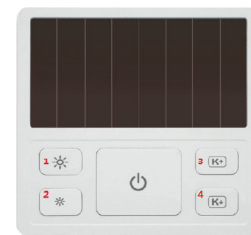

Wall Switch (WSBP):



## FTRV Series Design Details & Photometry

2x2

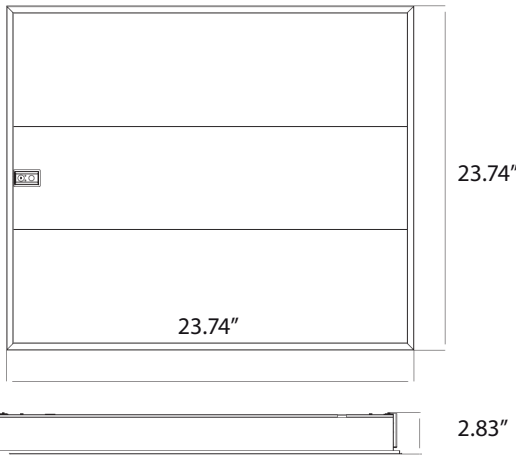

2x4

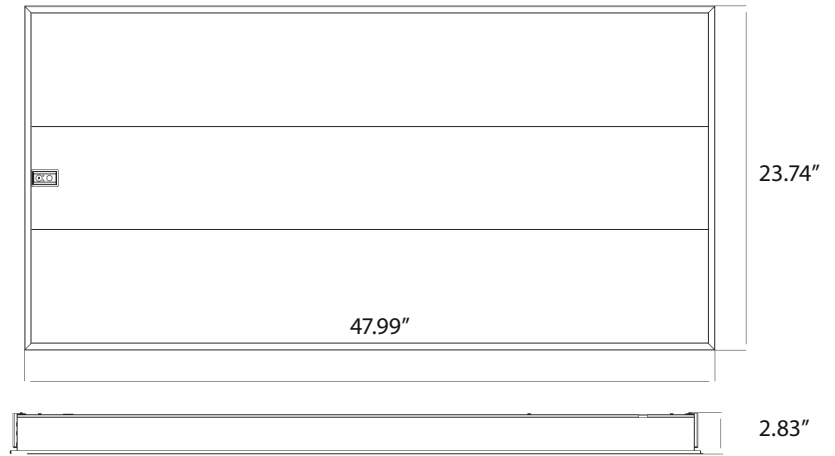

## FTRV Series Photometric Data

FTRV22-20W-35K

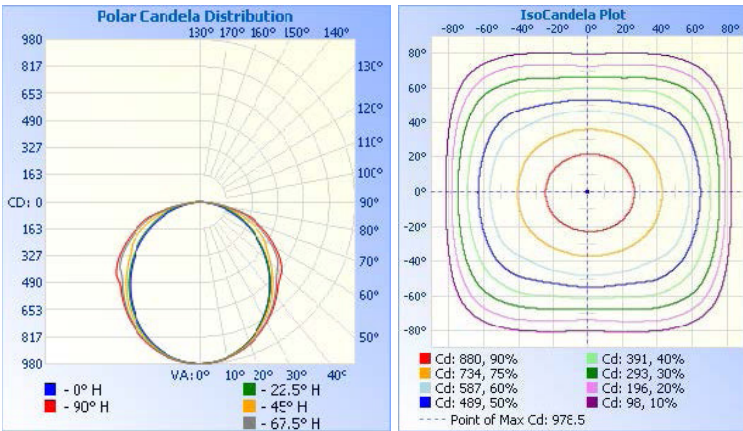

FTRV22-26W-35K

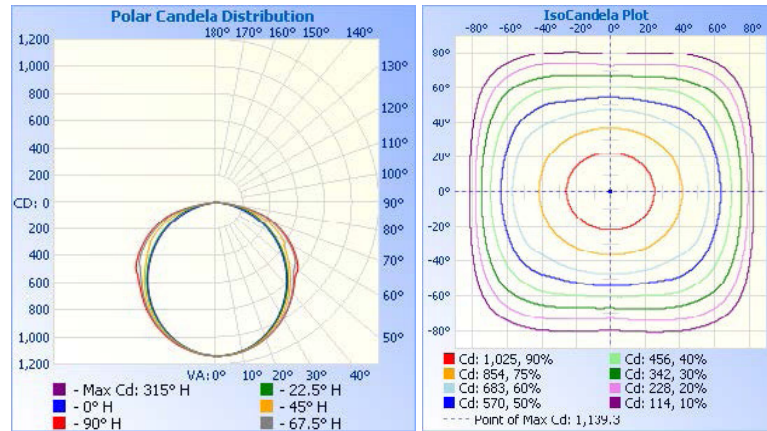

**Illuminance at a Distance**

Center Beam fc	Beam Width
3.39 fc	46.8 ft 70.0 ft
0.85 fc	93.5 ft 140.1 ft
0.38 fc	140.3 ft 210.1 ft
0.21 fc	187.1 ft 280.2 ft
0.14 fc	233.9 ft 350.2 ft
0.09 fc	280.6 ft 420.3 ft

Vert. Spread: 108.3°  
Horiz. Spread: 128.2°

**Illuminance at a Distance**

Center Beam fc	Beam Width
3.94 fc	47.2 ft 69.0 ft
0.99 fc	94.3 ft 137.9 ft
0.44 fc	141.5 ft 206.9 ft
0.25 fc	188.6 ft 275.9 ft
0.16 fc	235.8 ft 344.9 ft
0.11 fc	282.9 ft 413.8 ft

Vert. Spread: 108.4°  
Horiz. Spread: 127.5°

## FTRV Series Photometric Data

### FTRV22-HE-26W-35K

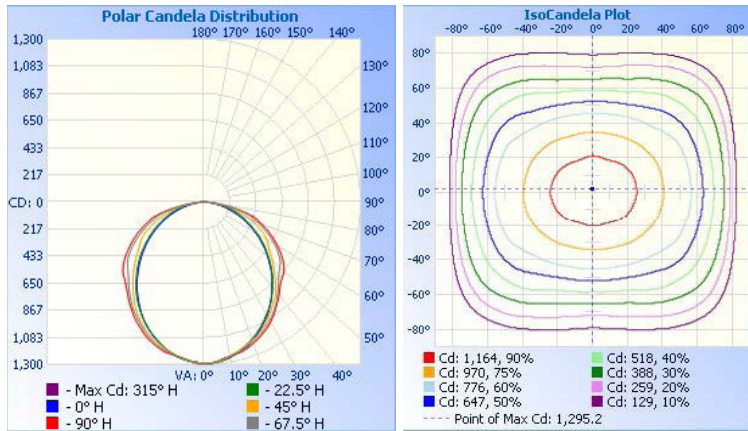

**Illuminance at a Distance**

Center Beam ft	Beam Width	
17.0ft	4.47 ft	43.6 ft 66.9 ft
34.0ft	1.12 ft	87.1 ft 133.8 ft
51.0ft	0.50 ft	130.7 ft 200.7 ft
68.0ft	0.28 ft	174.3 ft 267.5 ft
85.0ft	0.18 ft	217.8 ft 334.4 ft
102.0ft	0.12 ft	261.4 ft 401.3 ft

Vert. Spread: 101.1°  
Horiz. Spread: 126.1°

### FTRV22-32W-35K

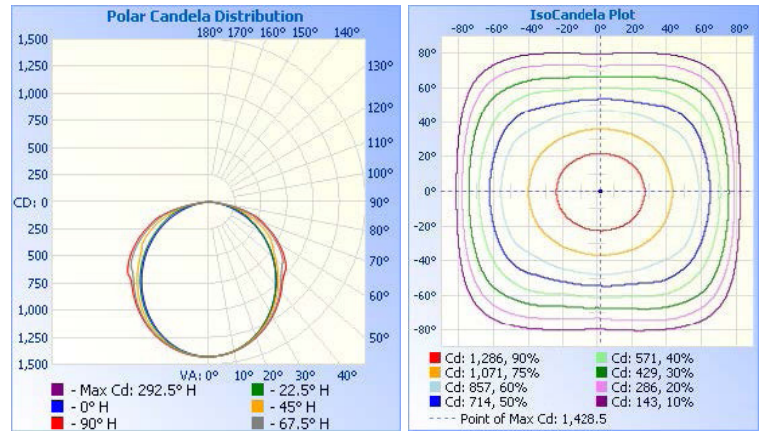

**Illuminance at a Distance**

Center Beam ft	Beam Width	
17.0ft	4.94 ft	46.9 ft 69.1 ft
34.0ft	1.24 ft	93.7 ft 138.3 ft
51.0ft	0.55 ft	140.6 ft 207.4 ft
68.0ft	0.31 ft	187.5 ft 276.5 ft
85.0ft	0.20 ft	234.3 ft 345.7 ft
102.0ft	0.14 ft	281.2 ft 414.8 ft

Vert. Spread: 108.1°  
Horiz. Spread: 127.6°

### FTRV24-HE-26W-35K

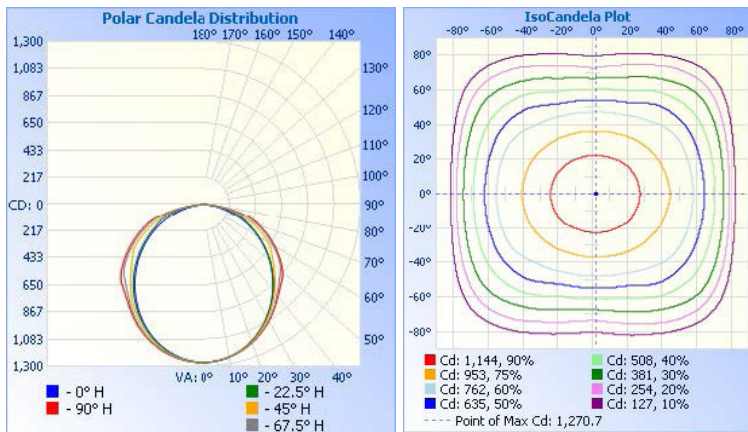

**Illuminance at a Distance**

Center Beam ft	Beam Width	
17.0ft	4.39 ft	47.7 ft 60.1 ft
34.0ft	1.10 ft	95.3 ft 136.1 ft
51.0ft	0.49 ft	143.0 ft 204.2 ft
68.0ft	0.27 ft	190.6 ft 272.3 ft
85.0ft	0.18 ft	238.3 ft 340.4 ft
102.0ft	0.12 ft	285.9 ft 408.4 ft

Vert. Spread: 109.0°  
Horiz. Spread: 126.9°

### FTRV24-32W-35K

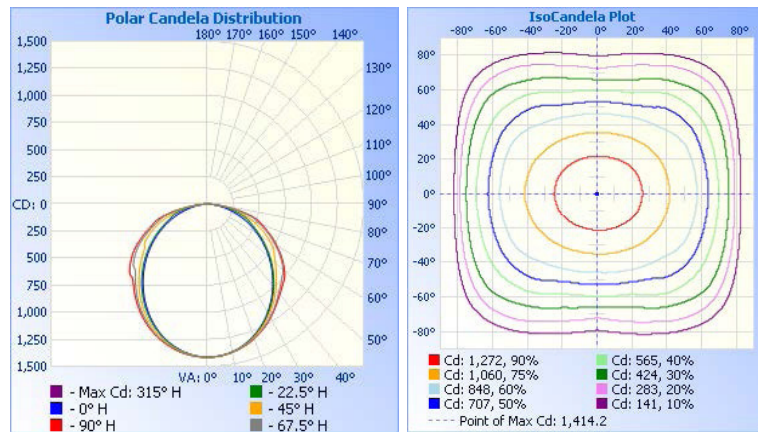

**Illuminance at a Distance**

Center Beam ft	Beam Width	
17.0ft	4.89 ft	44.8 ft 67.6 ft
34.0ft	1.22 ft	89.6 ft 135.2 ft
51.0ft	0.54 ft	134.5 ft 202.7 ft
68.0ft	0.31 ft	179.3 ft 270.3 ft
85.0ft	0.20 ft	224.1 ft 337.9 ft
102.0ft	0.14 ft	260.9 ft 405.5 ft

Vert. Spread: 105.0°  
Horiz. Spread: 126.0°

## FTRV Series Photometric Data FTRV24-40W-35K

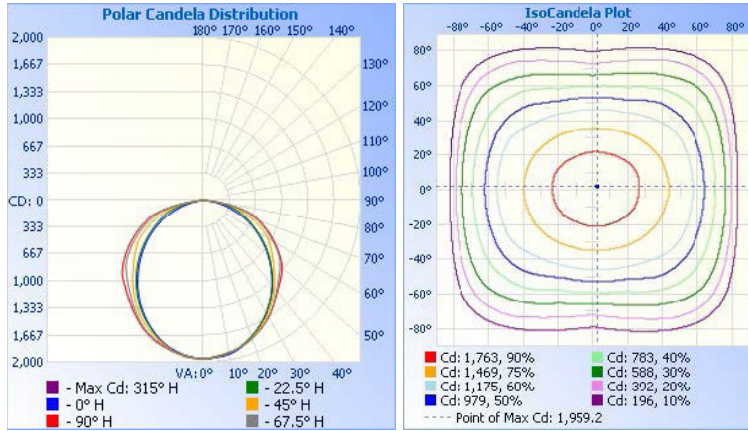

**Illuminance at a Distance**

Distance	Center Beam ft	Beam Width	
17.0ft	6.77 ft	45.0 ft	67.1 ft
34.0ft	1.69 ft	09.9 ft	134.1 ft
51.0ft	0.75 ft	134.9 ft	201.2 ft
68.0ft	0.42 ft	179.9 ft	268.3 ft
85.0ft	0.27 ft	224.9 ft	335.4 ft
102.0ft	0.19 ft	269.8 ft	402.4 ft

Vert. Spread: 105.8°  
 Horiz. Spread: 126.2°

## FTRV24-50W-50K

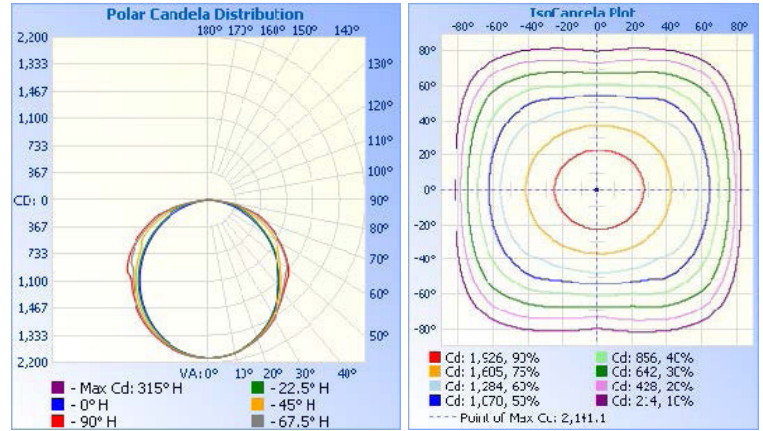

**Illuminance at a Distance**

Distance	Center Beam ft	Beam Width	
17.0ft	7.40 ft	47.5 ft	60.4 ft
34.0ft	1.85 ft	95.1 ft	136.8 ft
51.0ft	0.82 ft	142.6 ft	205.1 ft
68.0ft	0.46 ft	190.1 ft	273.5 ft
85.0ft	0.30 ft	237.7 ft	341.9 ft
102.0ft	0.21 ft	285.2 ft	410.3 ft

Vert. Spread: 108.8°  
 Horiz. Spread: 127.1°

## FTRV Series Installation Instructions

For all FTRV Series Troffer Product

### Recessed T-Bar Mounting (STD)

(Standard lay in Troffer to ceiling grid)

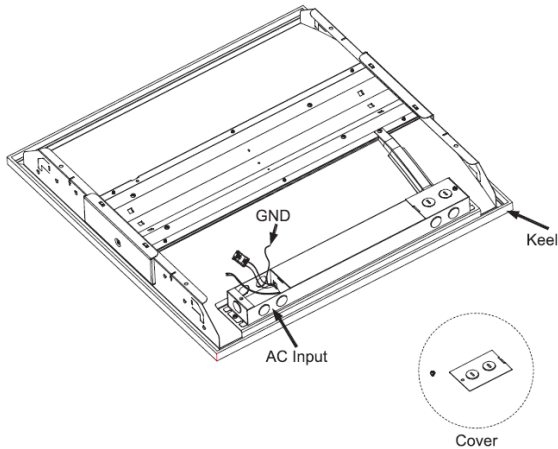

1. Turn off the power. Remove the AC input end cover by tools. Place the troffer to the ceiling keel.

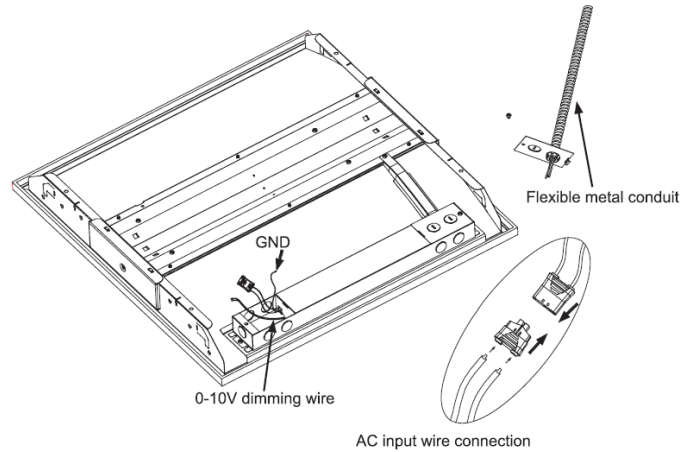

2. Poke through the hole of cover by tool and then put the flexible metal conduit through the holes as shown. Or you can poke the side hole of the driver and let the conduit through the hole. Connect the L, N, and GND wires well. If needed, connect the dimming wire.

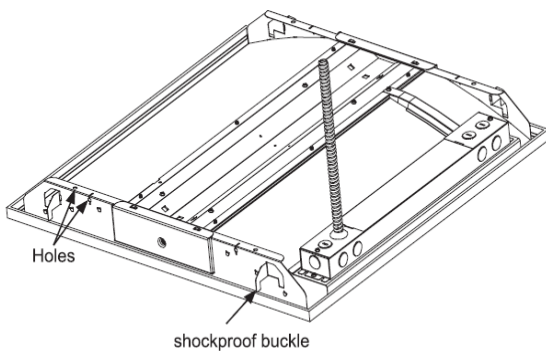

3. Place back the cover. Fixate the troffer by letting safety cable go through the side round holes to the ceiling. Bend the shockproof buckle outside 90 degree.

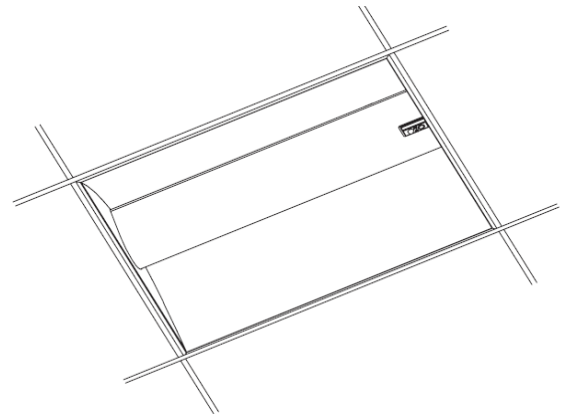

4. Turn on the power. The troffer is on. The recessed mounting installation is finished.

### Important Safeguards

- 1) Before installing this fixture or doing any maintenance, make sure to turn off the power supply.
- 2) Do not use outdoors.
- 3) Do not use this equipment for other than intended use.
- 4) Product must be installed in accordance with NEC or your local electrical code. If you are not familiar with these codes and requirements, consult a qualified electrician.

### WARNING ⚠️

RISK OF ELECTRICAL SHOCK  
 Avertissement: Risque de choc électrique  
 Access above ceiling required  
 For dry locations only

### WARNING ⚠️

Turn power off at circuit breaker or fuse box.  
 Do not rely on wall switch alone to turn off power.  
 Failure to do so may cause a shocking hazard and damage this electronic fixture!

## FTRV Series Installation Instructions

### Universal Kit for Troffer & Panel Fixtures

#### Drywall Flange Kit (DWK)

#### Description

Drywall Mounting Kit provides flanges for all typical recessed fluorescent fixtures. This allows for fixtures to be installed in ceilings where grids are not used (i.e. flush Gypsum ceilings). Can be used with any grid size recessed fluorescent fixture.

#### Ceiling Openings

Type	Ceiling opening
1x4	12.5" x 24.5"
2x2	24.5" x 24.5"
2x4	24.5" x 48.5"

**Drywall Mounting Kit (SMK) will need to be ordered separately and put together in field**



T-Frame Side Support (2 pcs.)

T-Frame End Support (2 pcs.)

T-Frame Lock Angle (4 pcs.)

#### Installation Instructions

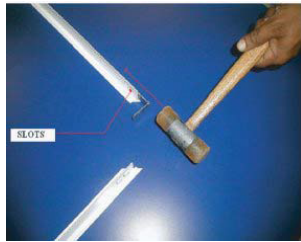

**Step 1:** Insert lock angle into slot on T-frame Support Rail. Tap lock angle into slot until tab locks into place (see picture above)



**Step 2:** Insert lock angle into slot on another T-frame Support Rail so they are perpendicular as shown on picture. Tap lock angle into slot until tab locks into place.



**Step 3:** Repeat 1 & 2 for other 3 corners

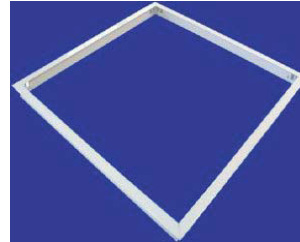

**Step 4:** Insert assembled T-frame kit into ceiling cavity.



**Step 5:** Suspend frame from four points using the holes provided on the supports.



**Step 6:** Wire and insert fixture into ceiling and maneuver into place just as in a grid ceiling.



**Step 7:** Installation finished.

#### WARNING ⚠️

RISK OF ELECTRICAL SHOCK  
Avertissement: Risque de choc électrique  
Access above ceiling required  
For dry locations only

#### WARNING ⚠️

Turn power off at circuit breaker or fuse box.  
Do not rely on wall switch alone to turn off power.  
Failure to do so may cause a shocking hazard and damage this electronic fixture!

#### Important Safeguards

- 1) Before installing this fixture or doing any maintenance, make sure to turn off the power supply.
- 2) Do not use outdoors.
- 3) Do not use this equipment for other than intended use.
- 4) Must be installed in accordance with NEC or your local electrical code. If you are not familiar with these codes and requirements, consult a qualified electrician.



## FTRV Series Installation Instructions

Universal kit for all Troffer and Panel Fixtures

### Surface Mounting Kit (SMK)



**Step 1:** TO AVOID ELECTRIC SHOCK HAZARD, DISCONNECT THE POWER AT THE PANEL BOARD (CIRCUIT BOX) BEFORE BEGINNING INSTALLATION!

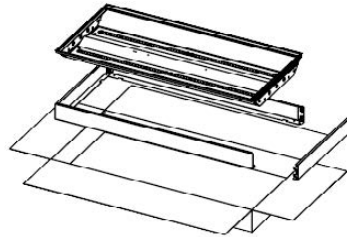

**Step 2:** Carefully remove fixture from packaging. Use gloves to prevent dirt and oils from transferring to the unit. Inspect the fixture for any defects before proceeding.

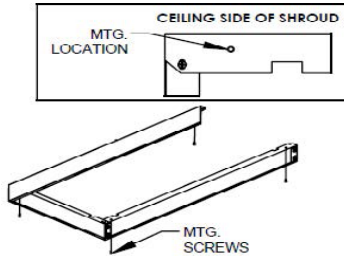

**Step 3:** Take note of mounting location dimensions, and mark locations on the ceiling as desired. Using approved hardware, secure the 3 pc shroud assembly to the ceiling by the mounting locations as shown.

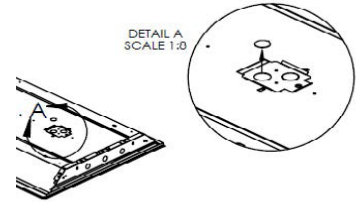

**Step 4:** Remove 7/8" knockout from the access cover in desired location to allow for wiring. Bring wiring thru knockout.

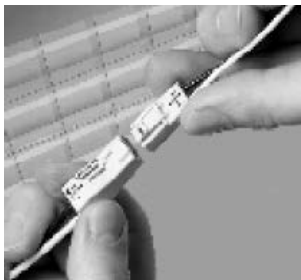

**Step 5:** Wire the fixture in accordance with all local, state and national codes. Test the fixture.

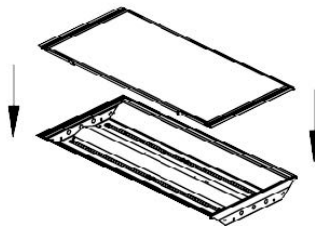

**Step 6:** Install the door to the fixture, (if not shipped installed). Make sure the door is latched properly.

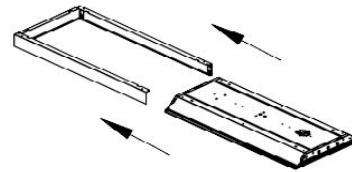

**Step 7:** After ensuring the shroud assembly is securely mounted to the ceiling, slide the 131 fixture in to the open end. Allow the fixture to rest on the inside faces of the shroud.

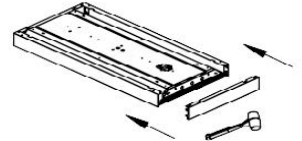
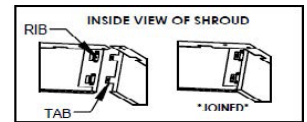

**Step 8:** Secure the last piece of the shroud to the assembly by lining up the tabs and the ribs as shown. Gently tap the end piece in to place with a rubber mallet.

## Important Safeguards

- 1) Before installing this fixture or doing any maintenance, make sure to turn off the power supply.
- 2) Do not use outdoors.
- 3) Do not use this equipment for other than intended use.
- 4) Product must be installed in accordance with NEC or your local electrical code. If you are not familiar with these codes and requirements, consult a qualified electrician.

## WARNING ⚠️

RISK OF ELECTRICAL SHOCK  
Avertissement: Risque de choc électrique  
Access above ceiling required  
For dry locations only

## WARNING ⚠️

Turn power off at circuit breaker or fuse box.  
Do not rely on wall switch alone to turn off power.  
Failure to do so may cause a shocking hazard and damage this electronic fixture!